

## TO-18 Plastic-Encapsulate Transistors

### FEATURES

- High DC Current Gain
- Low Collector Saturation Voltage
- High Power Dissipation
- TRANSISTOR (NPN)

### MECHANICAL DATA

- Case style: TO-18 molded plastic
- Mounting position: any

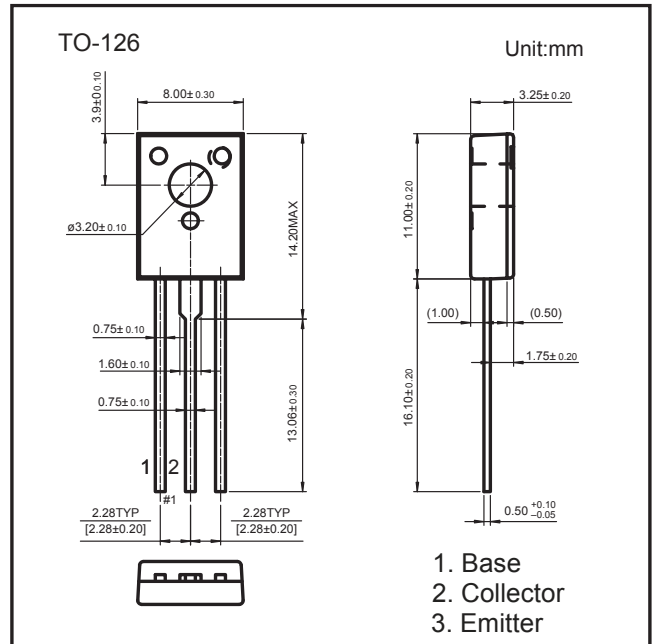

## MAXIMUM RATINGS AND CHARACTERISTICS

@ 25°C Ambient Temperature (unless otherwise noted)

Symbol	Parameter	Value	Unit
$V_{CBO}$	Collector-Base Voltage	150	V
$V_{CEO}$	Collector-Emitter Voltage	100	V
$V_{EBO}$	Emitter-Base Voltage	8	V
$I_C$	Collector Current	3	A
$P_C$	Collector Power Dissipation	1.25	W
$R_{\theta JA}$	Thermal Resistance From Junction To Ambient	100	°C/W
$T_j$	Junction Temperature	150	°C
$T_{stg}$	Storage Temperature	-55~+150	°C

### ORDERING INFORMATION

Part Number	Package	Packing Method	Pack Quantity
KSD1692	TO-18	Bulk	200pcs/Bag
KSD1692-TU	TO-18	Tube	60pcs/Tube

Parameter	Symbol	Test conditions	Min	Typ	Max	Unit
Collector-base breakdown voltage	$V_{(BR)CBO}$	$I_C=1mA, I_E=0$	150			V
Collector-emitter breakdown voltage	$V_{CEO(SUS)}$	$I_C=30mA, I_B=0$	100			V
Emitter-base breakdown voltage	$V_{(BR)EBO}$	$I_E=5mA, I_C=0$	8			V
Collector cut-off current	$I_{CBO}$	$V_{CB}=100V, I_E=0$			10	$\mu A$
Emitter cut-off current	$I_{EBO}$	$V_{EB}=5V, I_C=0$			2	mA
DC current gain	$h_{FE(1)}$	$V_{CE}=2V, I_C=1.5A$	2K		20K	
	$h_{FE(2)}$	$V_{CE}=2V, I_C=3A$	1K			
Collector-emitter saturation voltage	$V_{CE(sat)}$	$I_C=1.5A, I_B=1.5mA$			1.2	V
Base-emitter saturation voltage	$V_{BE(sat)}$	$I_C=1.5A, I_B=1.5mA$			2	V

\*Pulse test: pulse width  $\leq 300\mu s$ , duty cycle  $\leq 1.5\%$ .

### CLASSIFICATION OF $h_{FE(1)}$

RANK	O	Y	G
RANGE	2K-5K	4K-12K	6K-20K